

FEATURES

- 6.0 V to 15 V supply range**
- Supply current: 15 μ A maximum**
- Low noise: 15 μ V p-p typical (0.1 Hz to 10 Hz)**
- High output current: 5 mA**
- Temperature range: -40°C to $+125^{\circ}\text{C}$**
- Pin-compatible with the REF02/REF19x**

APPLICATIONS

- Portable instrumentation**
- Precision reference for 5 V systems**
- ADC and DAC reference**
- Solar-powered applications**
- Loop-current powered instruments**

GENERAL DESCRIPTION

The ADR293 is a low noise, micropower precision voltage reference that utilizes an XFET® (eXtra implanted junction FET) reference circuit. The XFET architecture offers significant performance improvements over traditional band gap and buried Zener-based references. Improvements include one quarter the voltage noise output of band gap references operating at the same current, very low and ultralinear temperature drift, low thermal hysteresis, and excellent long-term stability.

The ADR293 is a series voltage reference providing stable and accurate output voltage from a 6.0 V supply. Quiescent current is only 15 μ A maximum, making this device ideal for battery powered instrumentation. Three electrical grades are available offering initial output accuracy of ± 3 mV, ± 6 mV, and ± 10 mV. Temperature coefficients for the three grades are 8 ppm/ $^{\circ}\text{C}$,

15 ppm/ $^{\circ}\text{C}$, and 25 ppm/ $^{\circ}\text{C}$ maximum. Line regulation and load regulation are typically 30 ppm/V and 30 ppm/mA, respectively, maintaining the reference's overall high performance.

The ADR293 is specified over the extended industrial temperature range of -40°C to $+125^{\circ}\text{C}$. This device is available in the 8-lead SOIC and 8-lead TSSOP packages.

PIN CONFIGURATIONS

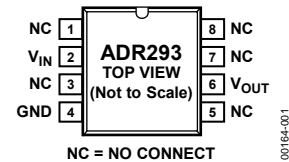

Figure 1. 8-Lead Narrow Body SOIC (R-8)

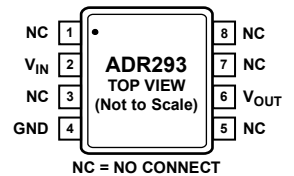

Figure 2. 8-Lead TSSOP (RU-8)

Table 1. ADR29x Products

Device	Output Voltage (V)	Initial Accuracy (%)	Temperature Coefficient (ppm/ $^{\circ}\text{C}$ max)
ADR291	2.500	0.08, 0.12, 0.24	8, 15, 25
ADR292	4.096	0.07, 0.10, 0.15	8, 15, 25
ADR293	5.000	0.06, 0.12, 0.20	8, 15, 25

Rev. C

Information furnished by Analog Devices is believed to be accurate and reliable. However, no responsibility is assumed by Analog Devices for its use, nor for any infringements of patents or other rights of third parties that may result from its use. Specifications subject to change without notice. No license is granted by implication or otherwise under any patent or patent rights of Analog Devices. Trademarks and registered trademarks are the property of their respective owners.

TABLE OF CONTENTS

Features	1	Device Power Dissipation Considerations.....	10
Applications.....	1	Basic Voltage Reference Connections	10
Pin Configurations	1	Noise Performance	10
General Description	1	Turn-On Time	10
Revision History	2	Applications.....	11
Specifications.....	3	A Negative Precision Reference Without Precision Resistors	11
Electrical Specifications.....	3	11
Absolute Maximum Ratings.....	5	A Precision Current Source	11
Thermal Resistance	5	Kelvin Connections.....	11
ESD Caution.....	5	Voltage Regulator for Portable Equipment	12
Typical Performance Characteristics	6	Outline Dimensions	13
Terminology	9	Ordering Guide	14
Theory of Operation	10		

REVISION HISTORY

9/10—Rev. B to Rev. C

Changes to Table 2 and Table 3.....	3
Changes to Table 4.....	4
Changes to Figure 10, Figure 11, Figure 13.....	7
Changes to Captions for Figure 17 to Figure 19.....	8

6/07—Rev. A to Rev. B

Updated Format.....	Universal
Changes to Table 1.....	1
Updated Outline Dimensions	13
Changes to Ordering Guide	13

3/01—Rev. 0 to Rev. A

SPECIFICATIONS

ELECTRICAL SPECIFICATIONS

$V_S = 6.0\text{ V}$, $T_A = 25^\circ\text{C}$, unless otherwise noted.

Table 2.

Parameter	Symbol	Conditions	Min	Typ	Max	Unit
OUTPUT VOLTAGE	V_{OUT}	$I_{OUT} = 0\text{ mA}$				
E Grade			4.997	5.000	5.003	V
F Grade			4.994	5.000	5.006	V
G Grade			4.990	5.000	5.010	V
INITIAL ACCURACY		$I_{OUT} = 0\text{ mA}$				
E Grade			-3		+3	mV
					0.06	%
F Grade			-6		+6	mV
					0.12	%
G Grade			-10		+10	mV
					0.20	%
LINE REGULATION	$\Delta V_{OUT} / \Delta V_{IN}$	6.0 V to 15 V, $I_{OUT} = 0\text{ mA}$				
E, F Grades				30	100	ppm/V
G Grade				40	150	ppm/V
LOAD REGULATION	$\Delta V_{OUT} / \Delta I_{LOAD}$	$V_S = 6.0\text{ V}$, $I_{OUT} = 0\text{ mA}$ to 5 mA				
E, F Grades				30	100	ppm/mA
G Grade				40	150	ppm/mA
LONG-TERM STABILITY	ΔV_{OUT}	After 1000 hours of operation @ 125°C		50		ppm
VOLTAGE NOISE	$e_{N\text{ p-p}}$	$f = 0.1\text{ Hz}$ to 10 Hz		15		$\mu\text{V p-p}$
VOLTAGE NOISE DENSITY	e_N	$f = 1\text{ kHz}$		640		$\text{nV}/\sqrt{\text{Hz}}$

$V_S = 6.0\text{ V}$, $T_A = -25^\circ\text{C}$ to $+85^\circ\text{C}$, unless otherwise noted.

Table 3.

Parameter	Symbol	Conditions	Min	Typ	Max	Unit
TEMPERATURE COEFFICIENT	TCV_{OUT}	$I_{OUT} = 0\text{ mA}$				
E Grade				3	8	ppm/ $^\circ\text{C}$
F Grade				5	15	ppm/ $^\circ\text{C}$
G Grade				10	25	ppm/ $^\circ\text{C}$
LINE REGULATION	$\Delta V_{OUT} / \Delta V_{IN}$	6.0 V to 15 V, $I_{OUT} = 0\text{ mA}$				
E, F Grades				35	150	ppm/V
G Grade				50	200	ppm/V
LOAD REGULATION	$\Delta V_{OUT} / \Delta I_{LOAD}$	$V_S = 6.0\text{ V}$, $I_{OUT} = 0\text{ mA}$ to 5 mA				
E, F Grades				20	150	ppm/mA
G Grade				30	200	ppm/mA

ADR293

$V_S = 6.0\text{ V}$, $T_A = -40^\circ\text{C}$ to $+125^\circ\text{C}$, unless otherwise noted.

Table 4.

Parameter	Symbol	Conditions	Min	Typ	Max	Unit
TEMPERATURE COEFFICIENT	TCV_{OUT}	$I_{OUT} = 0\text{ mA}$				
E Grade			3	10	ppm/ $^\circ\text{C}$	
F Grade			5	20	ppm/ $^\circ\text{C}$	
G Grade			10	30	ppm/ $^\circ\text{C}$	
LINE REGULATION	$\Delta V_{OUT}/\Delta V_{IN}$	6.0 V to 15 V, $I_{OUT} = 0\text{ mA}$				
E, F Grades			40	200	ppm/V	
G Grade			70	250	ppm/V	
LOAD REGULATION	$\Delta V_{OUT}/\Delta I_{LOAD}$	$V_S = 6.0\text{ V}$, $I_{OUT} = 0\text{ mA}$ to 5 mA				
E, F Grades			20	200	ppm/mA	
G Grade			30	300	ppm/mA	
SUPPLY CURRENT	I_S	@ 25 $^\circ\text{C}$				
			11	15	μA	
			15	20	μA	
THERMAL HYSTERESIS	$V_{OUT-HYS}$	8-lead SOIC_N		72		ppm
			8-lead TSSOP		157	

ABSOLUTE MAXIMUM RATINGS

Table 5.

Parameter	Rating
Supply Voltage	18 V
Output Short-Circuit Duration to GND	Indefinite
Storage Temperature Range	-65°C to +150°C
Operating Temperature Range	-40°C to +125°C
Junction Temperature Range	-65°C to +150°C
Lead Temperature (Soldering, 60 sec)	300°C

Stresses above those listed under Absolute Maximum Ratings may cause permanent damage to the device. This is a stress rating only; functional operation of the device at these or any other conditions above those indicated in the operational section of this specification is not implied. Exposure to absolute maximum rating conditions for extended periods may affect device reliability.

THERMAL RESISTANCE

θ_{JA} is specified for worst-case conditions; that is, θ_{JA} is specified for the device in socket testing. In practice, θ_{JA} is specified for the device soldered in a circuit board.

Table 6. Thermal Resistance

Package Type	θ_{JA}	θ_{JC}	Unit
8-Lead SOIC_N (R-8)	158	43	°C/W
8-Lead TSSOP (RU-8)	240	43	°C/W

ESD CAUTION



ESD (electrostatic discharge) sensitive device.

Charged devices and circuit boards can discharge without detection. Although this product features patented or proprietary protection circuitry, damage may occur on devices subjected to high energy ESD. Therefore, proper ESD precautions should be taken to avoid performance degradation or loss of functionality.

TYPICAL PERFORMANCE CHARACTERISTICS

$T_A = 25^\circ\text{C}$, unless otherwise noted.

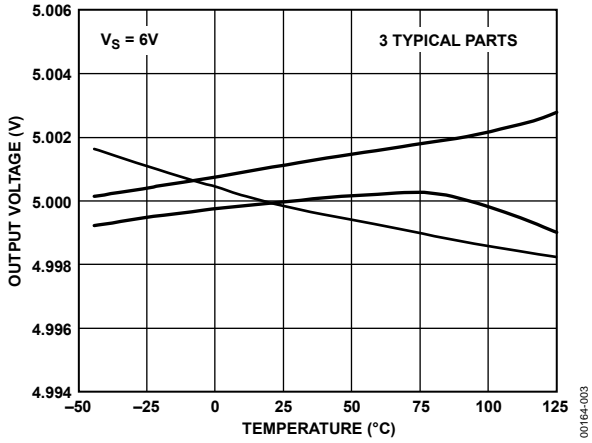

Figure 3. V_{OUT} vs. Temperature

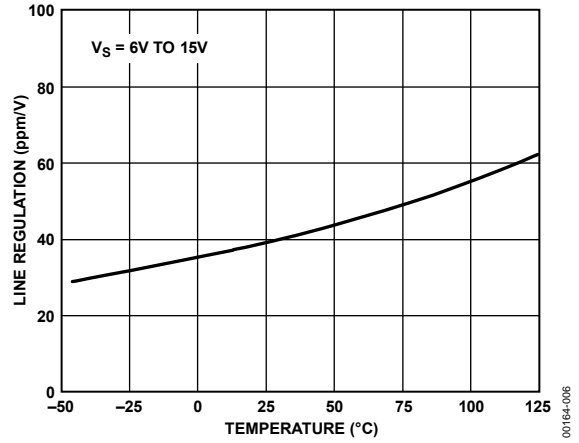

Figure 6. Line Regulation vs. Temperature

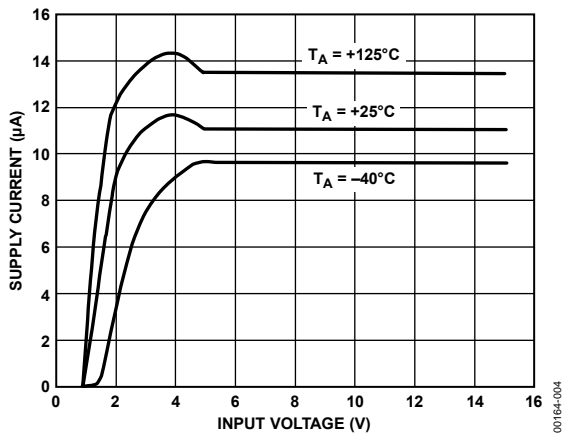

Figure 4. Supply Current vs. Input Voltage

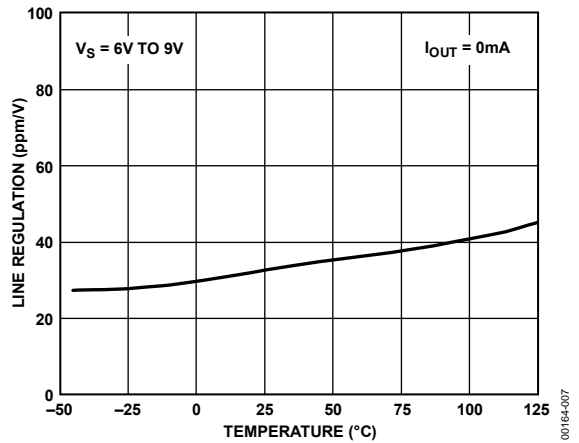

Figure 7. Line Regulation vs. Temperature

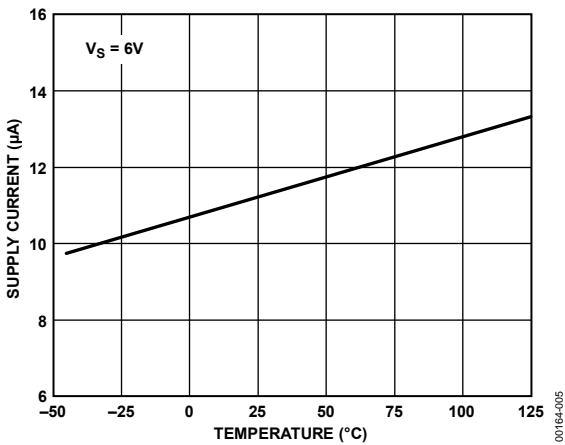

Figure 5. Supply Current vs. Temperature

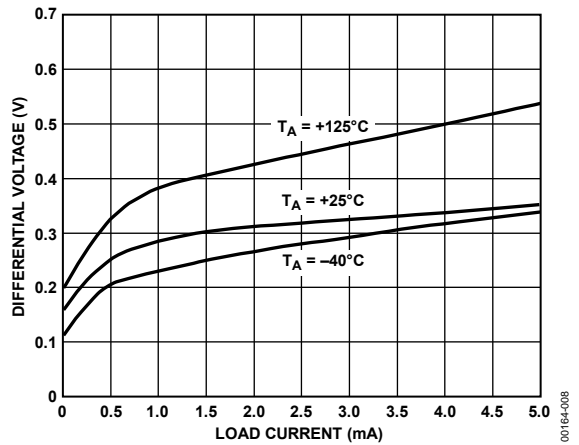

Figure 8. Minimum Input/Output Voltage Differential vs. Load Current

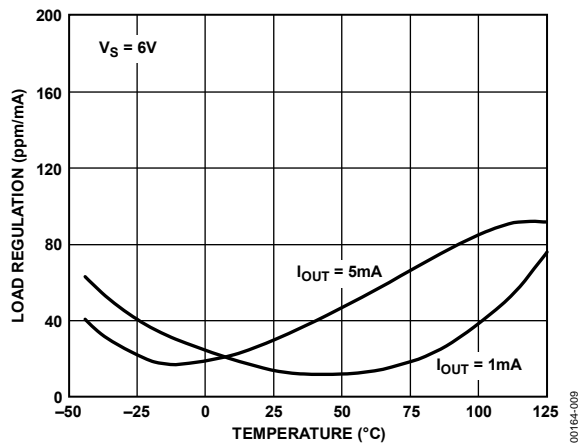

Figure 9. Load Regulation vs. Temperature

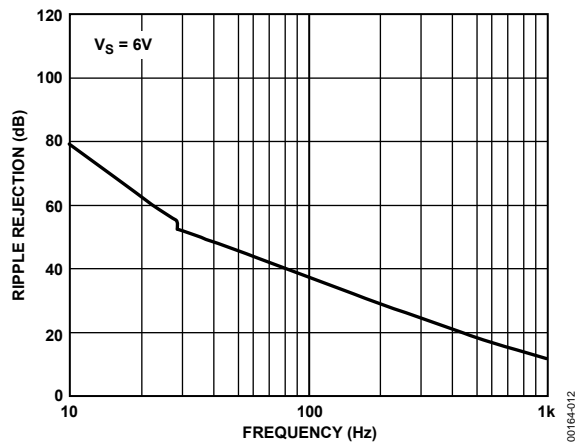

Figure 12. Ripple Rejection vs. Frequency

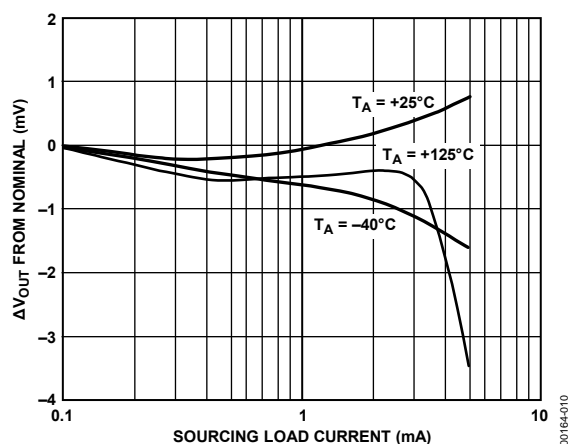

Figure 10. ΔV_{OUT} from Nominal vs. Load Current

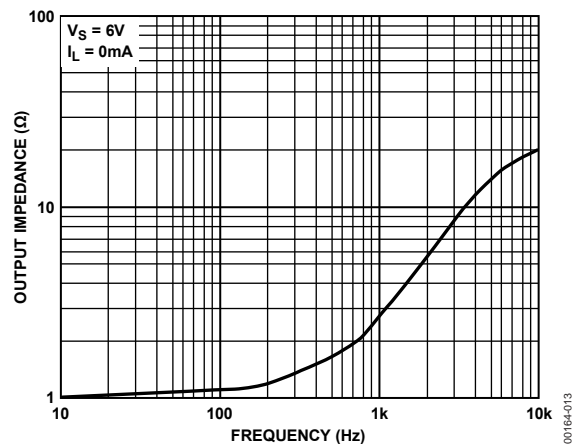

Figure 13. Output Impedance vs. Frequency

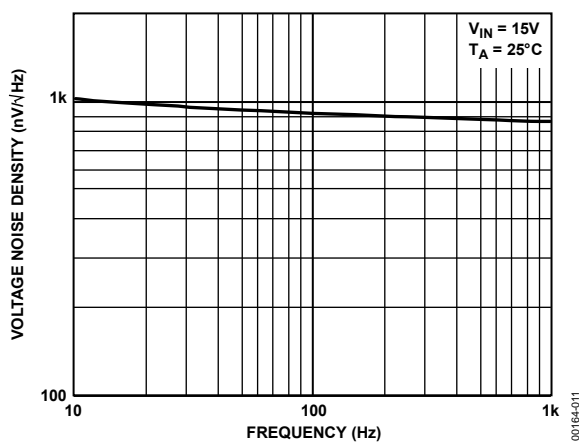

Figure 11. Voltage Noise Density vs. Frequency

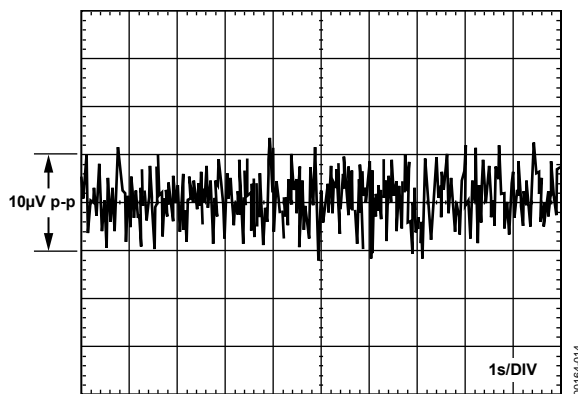

Figure 14. 0.1 Hz to 10 Hz Noise

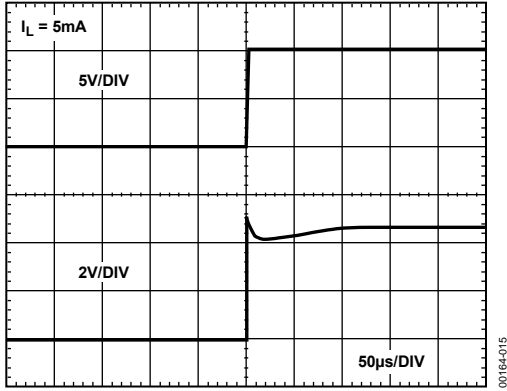

Figure 15. Turn-On Time

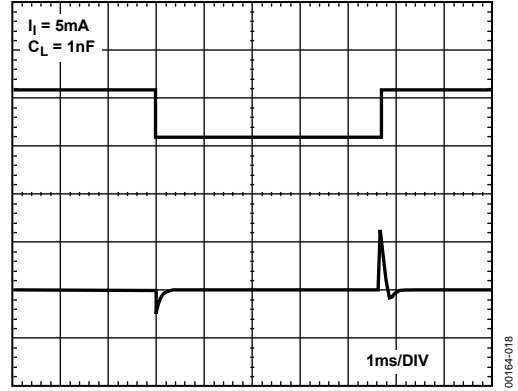

Figure 18. Load Transient Response

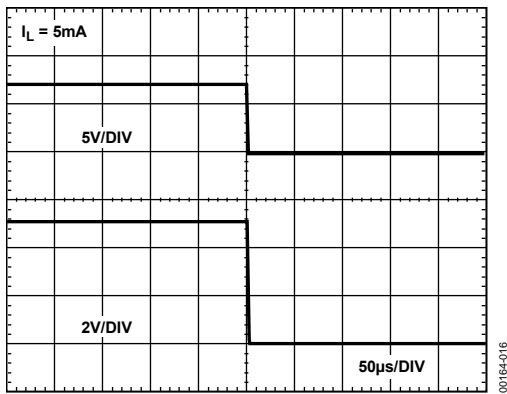

Figure 16. Turn-Off Time

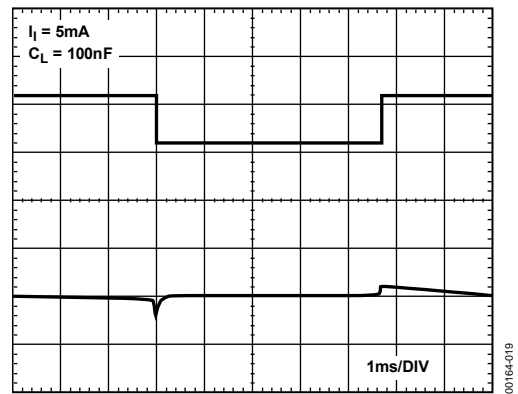

Figure 19. Load Transient Response

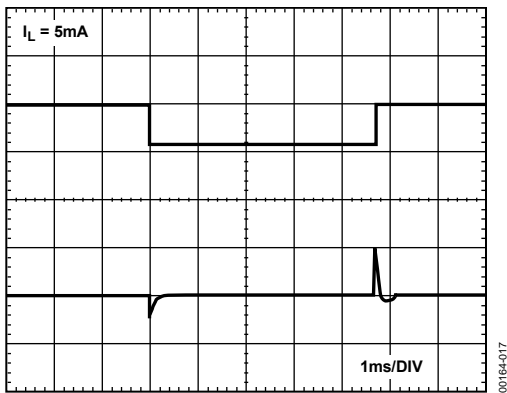

Figure 17. Load Transient Response

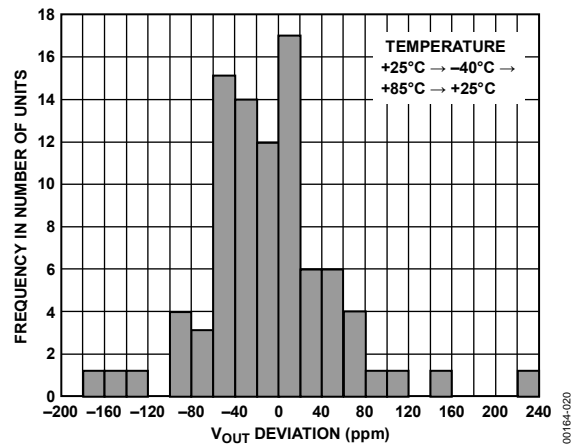

Figure 20. Typical Hysteresis for the ADR29x Product

TERMINOLOGY

Line Regulation

The change in output voltage due to a specified change in input voltage. It includes the effects of self-heating. Line regulation is expressed in percent per volt, parts per million per volt, or microvolts per volt change in input voltage.

Load Regulation

The change in output voltage due to a specified change in load current. It includes the effects of self-heating. Load regulation is expressed in microvolts per milliampere, parts per million per milliampere, or ohms of dc output resistance.

Long-Term Stability

Typical shift of output voltage of 25°C on a sample of parts subjected to high temperature operating life test of 1000 hours at 125°C.

$$\Delta V_{OUT} = V_{OUT}(t_0) - V_{OUT}(t_1)$$

$$\Delta V_{OUT} [\text{ppm}] = \frac{V_{OUT}(t_0) - V_{OUT}(t_1)}{V_{OUT}(t_0)} \times 10^6$$

where:

$V_{OUT}(t_0)$ = V_{OUT} at 25°C at time 0.

$V_{OUT}(t_1)$ = V_{OUT} at 25°C after 1000 hours operation at 125°C.

NC = No Connect

There are in fact connections at NC pins, which are reserved for manufacturing purposes. Users should not connect anything at NC pins.

Temperature Coefficient

The change of output voltage over the operating temperature change and normalized by the output voltage at 25°C, expressed in ppm/°C.

$$TCV_{OUT} [\text{ppm}/^\circ\text{C}] = \frac{V_{OUT}(T_2) - V_{OUT}(T_1)}{V_{OUT}(25^\circ\text{C}) \times (T_2) - T_1} \times 10^6$$

where:

$V_{OUT}(25^\circ\text{C})$ = V_{OUT} at 25°C.

$V_{OUT}(T_1)$ = V_{OUT} at Temperature 1.

$V_{OUT}(T_2)$ = V_{OUT} at Temperature 2.

Thermal Hysteresis

Thermal hysteresis is defined as the change of output voltage after the device is cycled through temperatures from +25°C to -40°C to +85°C and back to +25°C. This is a typical value from a sample of parts put through such a cycle.

$$V_{OUT-HYS} = V_{OUT}(25^\circ\text{C}) - V_{OUT-TC}$$

$$V_{OUT-HYS} [\text{ppm}] = \frac{V_{OUT}(25^\circ\text{C}) - V_{OUT-TC}}{V_{OUT}(25^\circ\text{C})} \times 10^6$$

where:

$V_{OUT}(25^\circ\text{C})$ = V_{OUT} at 25°C.

V_{OUT-TC} = $V_{OUT}(25^\circ\text{C})$ after temperature cycle at +25°C to -40°C to +85°C and back to +25°C.

APPLICATIONS

A NEGATIVE PRECISION REFERENCE WITHOUT PRECISION RESISTORS

In many current-output CMOS DAC applications where the output signal voltage must be of the same polarity as the reference voltage, it is often required to reconfigure a current-switching DAC into a voltage-switching DAC by using a 1.25 V reference, an op amp, and a pair of resistors. Using a current-switching DAC directly requires the need for an additional operational amplifier at the output to reinvert the signal. Therefore, a negative voltage reference is desirable from the point that an additional operational amplifier is not required for either reinversion (current-switching mode) or amplification (voltage-switching mode) of the DAC output voltage. In general, any positive voltage reference can be converted into a negative voltage reference by using an operational amplifier and a pair of matched resistors in an inverting configuration. The disadvantage to that approach is that the largest single source of error in the circuit is the relative matching of the resistors used.

The circuit illustrated in Figure 23 avoids the need for tightly matched resistors with the use of an active integrator circuit. In this circuit, the output of the voltage reference provides the input drive for the integrator. To maintain circuit equilibrium, the integrator adjusts its output to establish the proper relationship between the reference's V_{OUT} and GND. One caveat with this approach should be mentioned. Although rail-to-rail output amplifiers work best in the application, these operational amplifiers require a finite amount (mV) of headroom when required to provide any load current. The choice for the circuit's negative supply should take this issue into account.

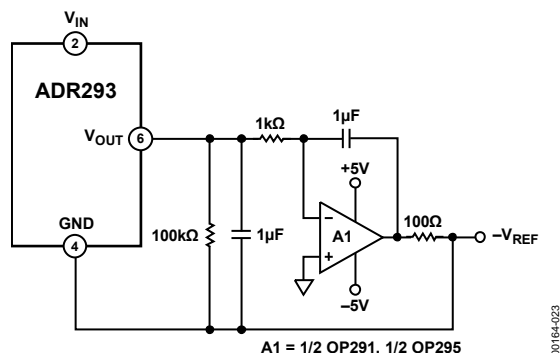

Figure 23. A Negative Precision Voltage Reference Uses No Precision Resistors

A PRECISION CURRENT SOURCE

Many times in low power applications, the need arises for a precision current source that can operate on low supply voltages. As shown in Figure 24, the ADR293 is configured as a precision current source. The circuit configuration illustrated is a floating current source with a grounded load. The output

voltage of the reference is bootstrapped across R_{SET} , which sets the output current into the load. With this configuration, circuit precision is maintained for load currents in the range from the reference's supply current, typically 15 μ A to approximately 5 mA.

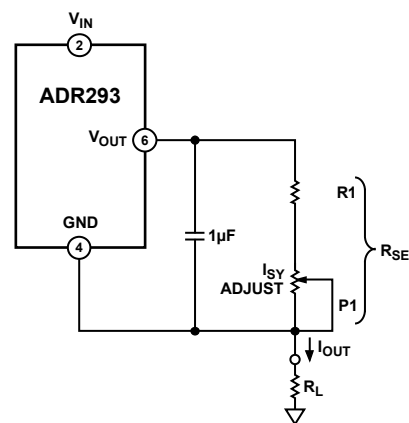

Figure 24. A Precision Current Source

KELVIN CONNECTIONS

In many portable instrumentation applications where PC board cost and area go hand-in-hand, circuit interconnects are very often of dimensionally minimum width. These narrow lines can cause large voltage drops if the voltage reference is required to provide load currents to various functions. In fact, a circuit's interconnects can exhibit a typical line resistance of 0.45 m Ω /square (1 oz. Cu, for example). Force and sense connections, also referred to as Kelvin connections, offer a convenient method of eliminating the effects of voltage drops in circuit wires. Load currents flowing through wiring resistance produce an error ($V_{ERROR} = R \times I_L$) at the load. However, the Kelvin connection in Figure 25 overcomes the problem by including the wiring resistance within the forcing loop of the op amp. Because the op amp senses the load voltage, op amp loop control forces the output to compensate for the wiring error and to produce the correct voltage at the load.

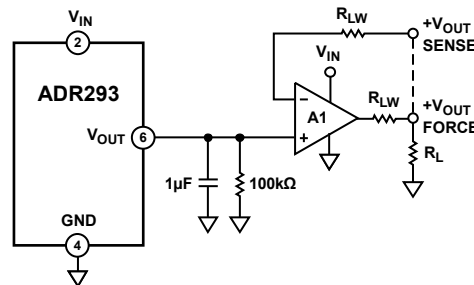

Figure 25. Advantage of Kelvin Connection

ADR293

VOLTAGE REGULATOR FOR PORTABLE EQUIPMENT

The ADR293 is ideal for providing a stable, low cost, and low power reference voltage in portable equipment power supplies. Figure 26 shows how the ADR293 can be used in a voltage regulator that not only has low output noise (as compared to switch mode design) and low power, but also a very fast recovery after current surges. Some precautions should be taken in the selection of the output capacitors. Too high an ESR (effective series resistance) could endanger the stability of the circuit. A solid tantalum capacitor, 16 V or higher, and an aluminum electrolytic capacitor, 10 V or higher, are recommended for C1 and C2, respectively. In addition, the path from the ground side of C1 and C2 to the ground side of R1 should be kept as short as possible.

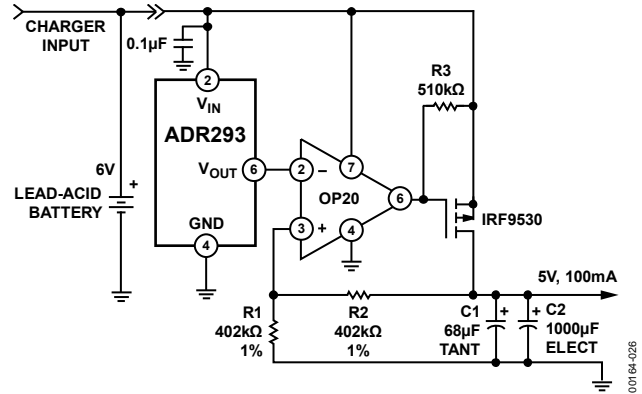
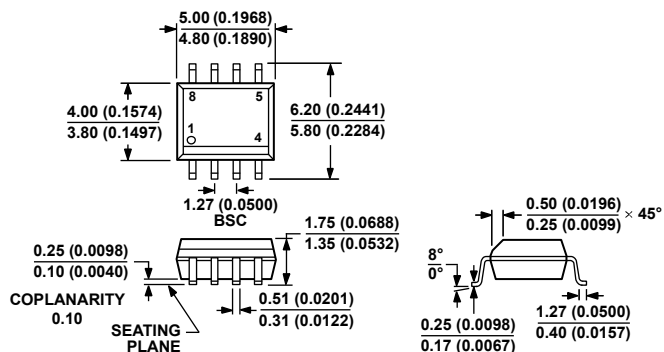

Figure 26. Voltage Regulator for Portable Equipment

OUTLINE DIMENSIONS



COMPLIANT TO JEDEC STANDARDS MS-012-AA
 CONTROLLING DIMENSIONS ARE IN MILLIMETERS; INCH DIMENSIONS
 (IN PARENTHESES) ARE ROUNDED-OFF MILLIMETER EQUIVALENTS FOR
 REFERENCE ONLY AND ARE NOT APPROPRIATE FOR USE IN DESIGN.

Figure 27. 8-Lead Standard Small Outline Package [SOIC_N]
 Narrow Body
 (R-8)

Dimensions shown in millimeters and (inches)

012407-A

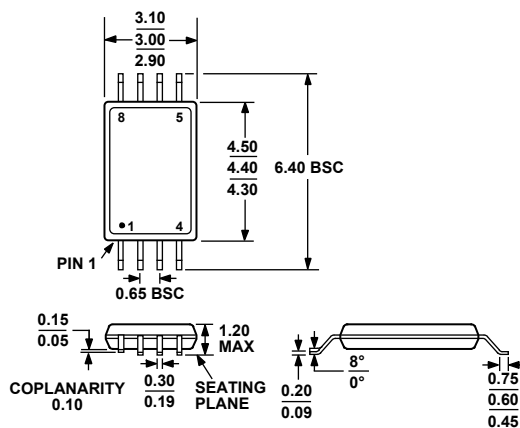

COMPLIANT TO JEDEC STANDARDS MO-153-AA

Figure 28. 8-Lead Thin Shrink Small Outline Package [TSSOP]
 (RU-8)

Dimensions shown in millimeters

ADR293

ORDERING GUIDE

Model ¹	Output Voltage (V)	Initial Accuracy (%)	Temperature Coefficient (ppm/°C max)	Temperature Range	Package Description	Package Option	Ordering Quantity
ADR293ERZ	5.00	0.06	8	-40°C to +125°C	8-Lead SOIC_N	R-8	98
ADR293ERZ-REEL	5.00	0.06	8	-40°C to +125°C	8-Lead SOIC_N	R-8	2,500
ADR293GRZ	5.00	0.20	25	-40°C to +125°C	8-Lead SOIC_N	R-8	98
ADR293GRZ-REEL7	5.00	0.20	25	-40°C to +125°C	8-Lead SOIC_N	R-8	1,000
ADR293GRUZ	5.00	0.20	25	-40°C to +125°C	8-Lead TSSOP	RU-8	96
ADR293GRUZ-REEL	5.00	0.20	25	-40°C to +125°C	8-Lead TSSOP	RU-8	2,500
ADR293GRUZ-REEL7	5.00	0.20	25	-40°C to +125°C	8-Lead TSSOP	RU-8	1,000

¹ Z = RoHS Compliant Part.

NOTES

ADR293

NOTES